

## Suction diffuser



TM04 7049 1510

**Fig. 1** Suction diffuser

### General information

A suction diffuser fitted between the suction pipe and the suction flange of a Grundfos pump gives the following advantages:

- The suction diffuser provides and ensures a uniform flow pattern to the suction side of the pump. This ensures a stable NPSH.
- The suction diffuser makes it possible to install the pump in a very narrow spacing as no long bends are necessary. The suction diffuser may even save floor space - and thus money.
- The suction diffuser incorporates a cylindrical strainer preventing impurities from entering the pump.
- The suction diffuser comes with a disposable, fine mesh, stainless steel start-up screen for capture and removal of foreign particulates in system piping.
- The suction diffuser has an adjustable support for mounting.
- The suction diffuser is easy to dismantle and service. Internal parts such as strainer can be easily removed, cleaned and/or replaced.

### Suction diffuser range

Suction diffusers are available in ANSI 125 flanges and ANSI 250 flanges, see technical data below, and a variety of sizes ranging from 1.5 x 2 inches to 12 x 12 inches suction and discharge ports, see dimensional table.

### Technical data

	ANSI 125	ANSI 250
Pumped liquid	Water	Water
Max. pressure	175 psi	250 psi
Max. liquid temperature	248 °F	248 °F
Test pressure	265 psi	426 psi
<b>Materials:</b>		
Body	ASTM 126 Class B (cast iron)	ASTM A395 (ductile iron)
Cover	ASTM 126 Class B (cast iron)	ASTM A395 (ductile iron)
O-ring	EPDM	
Screen	ASTM A240-304 (stainless steel)	

### Installation

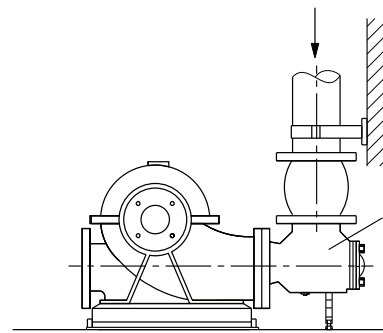

TM04 0096 4907

**Fig. 2** Pump installation with suction diffuser

### Sectional drawing and components

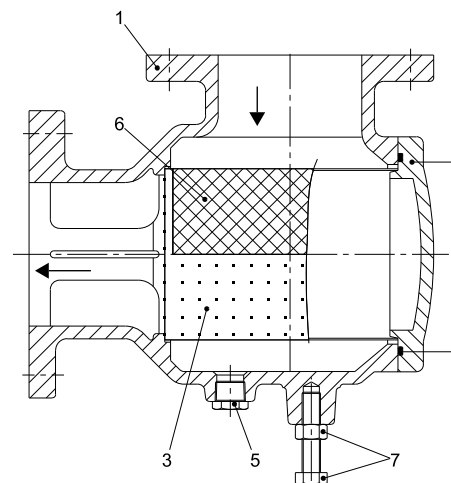

TM04 7050 1510

**Fig. 3** Sectional drawing of a suction diffuser

Po no.	Description	Po no.	Description
1	Body	5	Drain plug
2	Cover	6	Screen (temporary)
3	Screen (permanent)	7	Bolt, nut
4	O-ring		

# Accessories

## Dimensions and weights

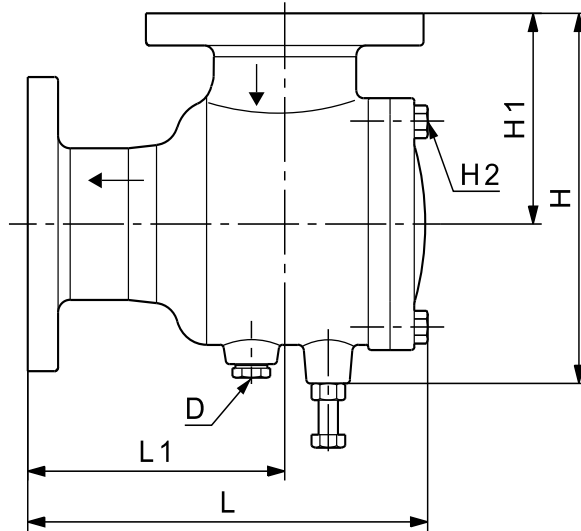

TM04 7051 1510

Fig. 4 Dimensional drawing of a suction diffuser

### ANSI 125

Inlet/outlet [inches]	Dimensions [inches]					H2 [no. of bolts]	Weight [lbs]
	L*	L1	H	H1	D-NPT		
2 x 1.5	8.2	5.0	7.2	4.0	1/2	4	21
2 x 2	8.3	5.1	7.2	4.0	1/2	4	22
2.5 x 2	9.7	6.0	8.6	5.0	1/2	4	29
2.5 x 2.5	9.7	6.0	8.6	5.0	1/2	4	34
3 x 2	11.1	7.1	9.6	5.6	1/2	4	39
3 x 2.5	11.1	7.1	9.6	5.6	1/2	4	39
3 x 3	11.1	7.1	9.6	5.6	1/2	4	40
4 x 3	12.9	8.3	11.4	6.5	3/4	6	60
4 x 4	12.9	8.3	11.4	6.5	3/4	6	64
5 x 4	14.3	9.4	12.7	6.9	3/4	6	91
5 x 5	13.9	9.0	12.7	6.9	3/4	6	93
6 x 4	15.7	10.1	14.4	8.0	3/4	6	120
6 x 5	15.9	10.3	14.4	8.0	3/4	6	122
6 x 6	15.6	10.1	14.4	8.0	3/4	6	137
8 x 6	18.9	11.9	17.5	10.0	3/4	6	188
8 x 8	18.9	11.9	17.5	10.0	3/4	6	201
10 x 8	23.5	14.3	20.6	11.5	1	6	305
10 x 10	23.5	14.3	20.6	11.5	1	6	314
12 x 8	28.0	17.9	23.5	12.9	1	8	441
12 x 10	28.0	17.9	23.5	12.9	1	8	448
12 x 12	28.0	17.9	23.5	12.9	1	8	455

\* Includes bolt head only, not washer.  
All dimension tolerances +/- .125".  
Screen Size: Mesh- 20#, Perforated Hole- 0.138".

### ANSI 250

Inlet/outlet [inches]	Dimensions [inches]					H2 [no. of bolts]	Weight [lbs]
	L*	L1	H	H1	D-NPT		
2 x 1.5	8.4	5.2	7.4	4.2	1/2	4	21
2 x 2	8.5	5.3	7.4	4.2	1/2	4	22
2.5 x 2	9.7	6.0	8.6	5.0	1/2	4	29
2.5 x 2.5	9.7	6.0	8.6	5.0	1/2	4	34
3 x 2	11.1	7.1	9.6	4.0	1/2	4	39
3 x 2.5	11.1	7.1	9.6	5.6	1/2	4	39
3 x 3	11.1	7.1	9.6	5.6	1/2	4	40
4 x 3	12.9	8.3	11.4	6.5	3/4	6	60
4 x 4	12.9	8.3	11.4	6.5	3/4	6	64
5 x 4	14.3	9.4	12.7	6.9	3/4	6	91
5 x 5	13.9	9.0	12.7	6.9	3/4	6	93
6 x 4	15.7	10.1	14.4	8.0	3/4	6	120
6 x 5	15.9	10.3	14.4	8.0	3/4	6	122
6 x 6	15.6	10.1	14.4	8.0	3/4	6	137
8 x 6	19.4	12.3	18.1	10.5	3/4	6	188
8 x 8	19.4	12.4	18.1	10.5	3/4	6	201
10 x 8	23.5	14.3	20.6	11.5	1	6	305
10 x 10	23.5	14.3	20.6	11.5	1	6	314
12 x 8	28.0	17.9	23.5	12.9	1	8	441
12 x 10	28.0	17.9	23.5	12.9	1	8	448
12 x 12	28.0	17.9	23.5	12.9	1	8	455

\* Includes bolt head only, not washer.  
All dimension tolerances +/- .125".  
Screen Size: Mesh- 20#, Perforated Hole- 0.138".

# Accessories

## Part numbers

Suction diffusers can be ordered using these part numbers:

Inlet/outlet [inches]	ANSI 125		ANSI 250	
	Reference No.	Part No.	Reference No.	Part No.
2 x 1.5	SD2025-125	97523145	SD2025-250	97523428
2 x 2	SD2020-125	97523146	SD2020-250	97523429
2.5 x 2	SD2520-125	97523147	SD2520-250	97523430
2.5 x 2.5	SD2525-125	97523148	SD2525-250	97523441
3 x 2	SD3020-125	97523149	SD3020-250	97523443
3 x 2.5	SD3025-125	97523150	SD3025-250	97523444
3 x 3	SD3030-125	96877828	SD3030-250	97523445
4 x 3	SD4030-125	97523151	SD4030-250	97523446
4 x 4	SD4040-125	96877830	SD4040-250	97523463
5 x 4	SD5040-125	96877831	SD5040-250	97523464
5 x 5	SD5050-125	97523152	SD5050-250	97523465
6 x 4	SD6040-125	97523153	SD6040-250	97523466
6 x 5	SD6050-125	97523154	SD6050-250	97523467
6 x 6	SD6060-125	96877842	SD6060-250	97523468
8 x 6	SD8060-125	97523155	SD8060-250	97523469
8 x 8	SD8080-125	97666296	SD8080-250	97523470
10 x 8	SD1080-125	97523156	SD1080-250	97523481
10 x 10	SD1010-125	97523157	SD1010-250	97523482
12 x 8	SD1280-125	97523158	SD1280-250	97523483
12 x 10	SD1210-125	97523159	SD1210-250	97523484
12 x 12	SD1212-125	97523160	SD1212-250	97534549

**NOTE:** Use part no. to order the suction diffuser.  
250# flanges are available upon request with 14 weeks delivery.

## Pressure drop

In operation the suction diffuser causes a minor pressure drop.

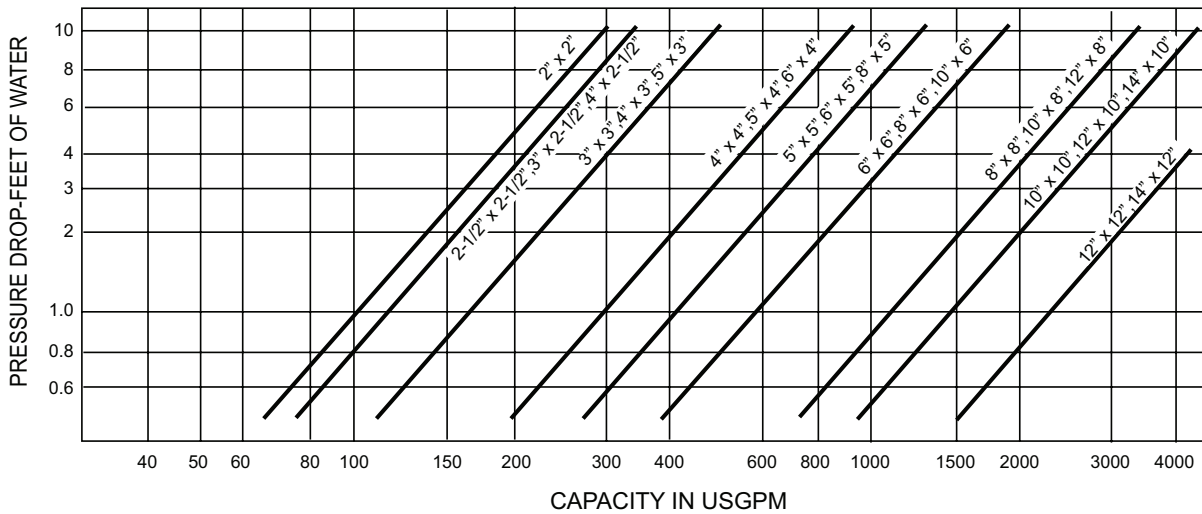

Fig. 5 Pressure drop graph for suction diffusers.

TM04 7175 1710